



Door Sign

- Door Signs
- 15 mm
- 26 mm
- Desktop Sign
- Wall Sign System
- Wall Sign Double Sided
- Sign Systems
- Toilet Logo Systems Chrome
- Decorative Toilet Signs
- Aluminum Panel Braille Signs
- ABS Plastic Braille Signs
- Plastic Chromed House Numbers
- Standoff Mount Acrylic Sign

- Türschilder
- 15 mm
- 26 mm
- Tischbeschilderungssystem
- Wandbeschilderungssystem
- Doppelseitige Wandschild
- Sign Systems
- Toilet Logo Systems Chrome
- Decorative Toilet Signs
- Aluminum Panel Braille Signs
- ABS Plastic Braille Signs
- Plastic Chromed House Numbers
- Standoff Mount Acrylic Sign



Door Sigs



See movie at our website www.mtdisplays.com.tr



Suitable for use in open-air spaces or public areas such as schools, offices, hospitals, etc.. It is an elegant and practical product. You merely need to open the front profile in order to change your documents. An anti-reflex PET cover protects your documents from tearing and suffering damage. It can be used both in portrait and landscape positions.

Ein elegantes Produkt welches in Schulen, Ausbildungsstätten, Büros, Krankenhäuser u.a sehr praktisch zum Einsatz gebracht werden kann. Durch leicht zu öffnende Profile können Dokumente leicht ausgewechselt werden. Die antireflex Schutzfolie schützt Ihre Dokumente vor Schmutz und Beschädigung. Der Artikel kann sowohl in Hochformat als auch im Querformat zum Einsatz gebracht werden.

Each door sign includes adhesive tape & mounting instruction sheet.
Jedes Paket enthält doppelseitiges Klebeband und eine Montageanleitung.

15 mm in top snap 8 mm poster & in bottom snap 8 mm poster is placed within the clamping system. 26 mm in top snap 11 mm poster & in bottom snap 11 mm poster is placed within the clamping system. Please clean the surface before applying the double-sided tape for better application.
Das Poster wird oben und unten um 8 mm durch die Klemmleisten verdeckt. Flächen vor dem anbringen des doppelseitigen Klebebands gründlich reinigen, um besseren Halt zu gewährleisten.



15 mm



26 mm

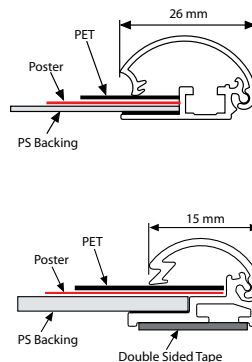
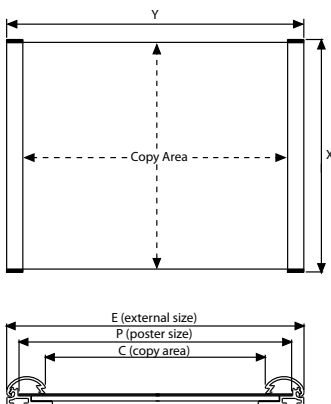

15 mm : Silver anodised aluminium Poster Snap				WEIGHT	PACKING SIZE (50 pcs)
ARTICLE	EXTERNAL (x-y)	POSTER	COPY	WITH PACKING	*W X H X D
UDS150NOA7	79 X 115 mm	74 X 105 mm	74 X 84 mm	0,745 kg	120 X 200 X 100 mm (15 Pcs)
UDS150NOA6	110 X 158 mm	105 X 148 mm	105 X 127 mm	0,600 kg	120 X 200 X 100 mm (5 Pcs)
UDS150NOA5	153 X 220 mm	148 X 210 mm	148 X 189 mm	2,880 kg	245 X 350 X 80 mm (20 Pcs)
UDS150NOA4	215 X 307 mm	210 X 297mm	210 X 276 mm	2,530 kg	245 X 350 X 80 mm (10 Pcs)
UDS150NA43	104 X 220 mm	99 X 210 mm	99 X 189 mm	2,880 kg	245 X 350 X 80 mm (30 Pcs)

26 mm : Silver anodised aluminium Poster Snap				WEIGHT	PACKING SIZE (50 pcs)
ARTICLE	EXTERNAL (x-y)	POSTER	COPY	WITH PACKING	*W X H X D
UDS0001050	56 X 177 mm	50 X 148 mm	50 X 126 mm	0,620 kg	120 X 200 X 100 mm (10 pcs)
UDS0002050	111 X 177 mm	105 X 148 mm	105 X 126 mm	0,545 kg	120 X 200 X 100 mm (5 pcs)
UDS0003050	111 X 326 mm	105 X 297 mm	105 X 275 mm	1,680 kg	245 X 350 X 80 mm (10 pcs)
UDS0004050	154 X 239 mm	148 X 210 mm	148 X 188 mm	0,930 kg	245 X 350 X 80 mm (10 pcs)
UDS0005050	216 X 326 mm	210 X 297 mm	210 X 275 mm	1,405 kg	245 X 350 X 80 mm (5 pcs)

*W:Width H: Height D: Depth





Desktop Sign



Offering a complete range, aluminium wall sign profiles are design to enable usage on a counter to match Wall Signs. Desktop Sign is fixed to a convenient reading angle to be seen by the customers easily. It is suitable for receptions, restaurants, cafés and many more. It is a practical product to change the message very often.

Aluminium Wall Sign Profile sind konzipiert um einen vergleichbaren Einsatz mit dem Wall Sign auf Theken zu ermöglichen. Der Desktop Sign wird in einem sehr bequemen Lesewinkel für Kunden ausgeliefert. Perfekt geeignet für Rezeptionen, Restaurants, Cafés und noch viele andere Bereiche.

 Use the suction cup enclosed to easily remove the insert. Verwenden Sie den Saugnapf um den Inhalt leicht hervor zu heben.

 Compatible signage methods; printed papers from common printers, cut vinyl, digitally printed vinyl, screen-printed materials. Kompatible Druckverfahren; bedrucktes Papier von herkömmlichen Druckern, Vinyl, digital bedrucktes Vinyl, Materialien bedruckt im Siebdruckverfahren. Eine Antireflexfolie bietet Schutz und eine klare Sicht auf die Mitteilung.

 Suitable for paper, plastic or any flexible material up to 1 mm thick. Geeignet für Papier, PVC, oder andere flexible Materialien bis zu einer Stärke von 1mm.

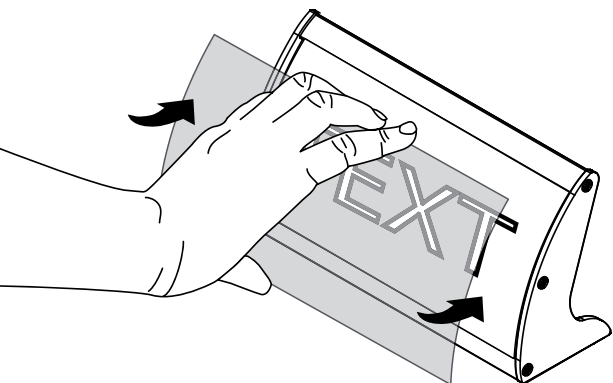

Suction Cup / UYAA006010

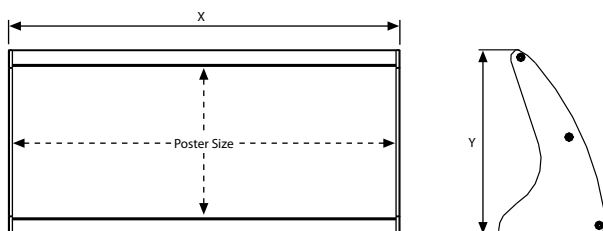

DESKTOP SIGN: Silver anodised aluminium			WEIGHT	PACKING SIZE
ARTICLE	EXTERNAL (x-y)	POSTER SIZE	WITH PACKING	*W X H X D
UMDS740N15	155 X 82 mm	74 X 150 mm	0,200 kg	110 X 180 X 75 mm
UMDS740N20	205 X 82 mm	74 X 200 mm	0,250 kg	110 X 230 X 75 mm
UMDS740N25	255 X 82 mm	74 X 250 mm	0,350 kg	110 X 280 X 75 mm
UMDS105N15	155 X 110 mm	105 X 150 mm	0,250 kg	140 X 170 X 85 mm
UMDS105N20	205 X 110 mm	105 X 200 mm	0,350 kg	140 X 230 X 85 mm
UMDS105N25	255 X 110 mm	105 X 250 mm	0,400 kg	140 X 280 X 85 mm
UMDS105N30	305 X 110 mm	105 X 300 mm	0,450 kg	140 X 330 X 85 mm
UMDS148N20	205 X 148 mm	148 X 200 mm	0,400 kg	180 X 230 X 95 mm
UMDS148N25	255 X 148 mm	148 X 250 mm	0,450 kg	180 X 280 X 95 mm
UMDS148N30	305 X 148 mm	148 X 300 mm	0,500 kg	180 X 320 X 95 mm

*W:Width H: Height D: Depth



Wall Sign System





Fast and simple!

The Wall Sign system is a perfect solution for wall posters and signs. It allows clear visibility for the poster and has an aesthetic curved shape. The stylish curved Wall Sign system in various sizes suits the room sign and way finding needs within the building. Designed for paper inserts and is offered in variety of profile types to match different projects. The front cover is anti-reflex which is flexed into place after inserting the paper. Poster inserts can be created from common inkjet or laser printers. Printed-paper inserts may be in portrait or landscape outline and various sizes fitting in 4 profile types.

Schnell und einfach!

Das Wall Sign System ist eine perfekte Lösung für Poster und Markierungen. Es ermöglicht die klare Sichtbarkeit des Posters und hat eine elegante gerundete Form. Der Artikel zeichnet Räume aus und verhilft im Gebäude Ihren richtigen Weg zu finden. Für Papiereinlagen entwickelt und wird in verschiedenen Profiltypen für verschiedene Zwecke angeboten. Die Schutzfolie ist antireflex und wird auf die Papiereinlage aufgelegt. Die Postereinlagen können mit herkömmlichen Tinten- oder Laserdruckern gedruckt werden. Papiereinlagen in Hoch- oder Querformat können dem Gebrauch entsprechend mit 4 verschiedenen Profiltypen eingesetzt werden.

 Each sign includes double sided tape, one suction cup and mounting instruction sheet. Jeder Artikel wird mit doppelseitigem Klebeband, einem Sauger und einer Montageanleitung geliefert.

 Use the suction cup to easily remove the inserts from the signs by simply attaching it to the inserts and pulling. Benutzen Sie den Sauger um die Schutzfolie abzuheben und die Einlagen auszutauschen, indem Sie den Sauger ansaugen lassen und leicht ziehen.

 Compatible signage methods; printed papers from common printers, cut vinyl, digitally printed vinyl, screen-printing. Please clean the surface before applying the double-sided tape for better application.

Variable Einlagemöglichkeiten, Drucke von herkömmlichen Druckern, zugeschnittenes Vinyl Digital bedrucktes Vinyl; Siebdrucke. Flächen vor dem anbringen des doppelseitigen Klebebands gründlich reinigen, um besseren Halt zu gewährleisten.



148 x 300 mm



105 x 250 mm



74 x 150 mm



52 x 150 mm



Flat cap

Arc cap

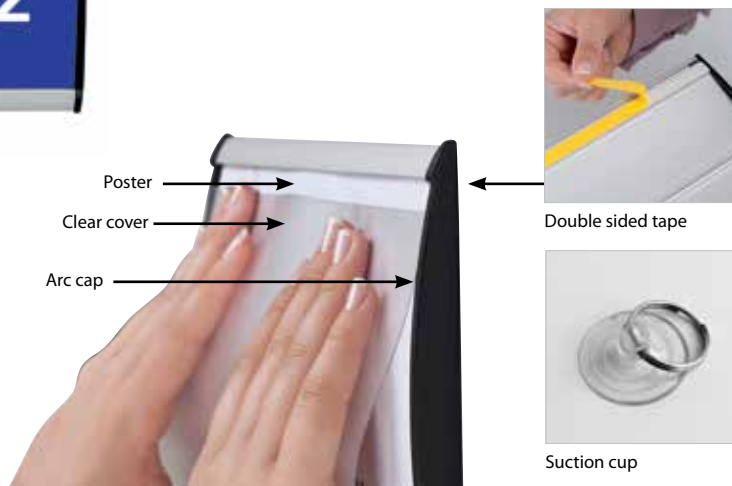

Model 52 mm

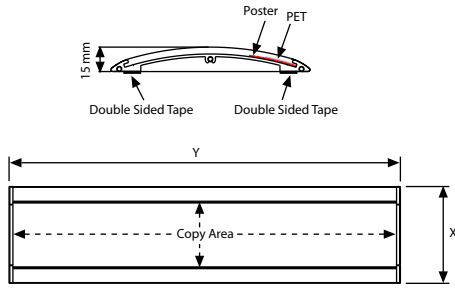

Model 74 mm

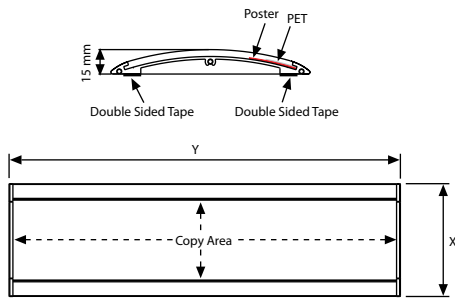

Model 105 mm

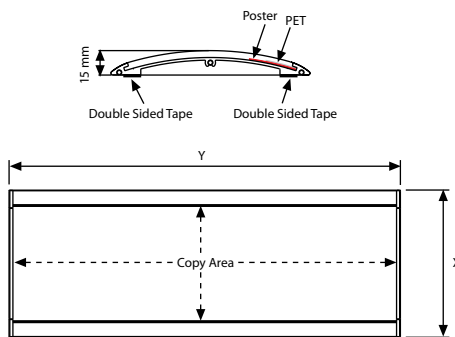

Model 148 mm

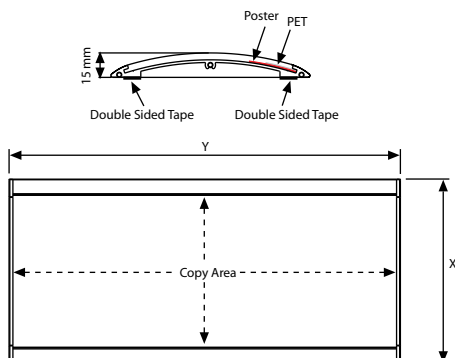

WALL SIGN SYSTEM 52 mm : Silver anodised aluminium					WEIGHT	PACKING SIZE (10 Pcs)
ARTICLE	MODEL	EXTERNAL (x-y)	POSTER	COPY	WITH PACKING	*W X H X D
UDS520NA10	Flat Endcap	68 X 106 mm	52 X 100 mm	46 X 100 mm	0,670 kg	160 X 140 X 100 mm
UDS520NA15	Flat Endcap	68 X 156 mm	52 X 150 mm	46 X 150 mm	0,985 kg	160 X 190 X 100 mm
UDS520NA20	Flat Endcap	68 X 206 mm	52 X 200 mm	46 X 200 mm	1,300 kg	160 X 240 X 100 mm
UDS520NA25	Flat Endcap	68 X 256 mm	52 X 250 mm	46 X 250 mm	1,615 kg	160 X 290 X 100 mm
UDS520NA30	Flat Endcap	68 X 306 mm	52 X 300 mm	46 X 300 mm	1,930 kg	160 X 340 X 100 mm
UDS520NA35	Flat Endcap	68 X 356 mm	52 X 350 mm	46 X 350 mm	2,245 kg	160 X 390 X 100 mm
UDS520NA40	Flat Endcap	68 X 406 mm	52 X 400 mm	46 X 400 mm	2,560 kg	160 X 440 X 100 mm
UDS520NA45	Flat Endcap	68 X 456 mm	52 X 450 mm	46 X 450 mm	2,875 kg	160 X 490 X 100 mm
UDS520NB10	Arc Endcap	68 X 106 mm	52 X 100 mm	46 X 94 mm	0,670 kg	160 X 140 X 100 mm
UDS520NB15	Arc Endcap	68 X 156 mm	52 X 150 mm	46 X 144 mm	0,985 kg	160 X 190 X 100 mm
UDS520NB20	Arc Endcap	68 X 206 mm	52 X 200 mm	46 X 194 mm	1,300 kg	160 X 240 X 100 mm
UDS520NB25	Arc Endcap	68 X 256 mm	52 X 250 mm	46 X 244 mm	1,615 kg	160 X 290 X 100 mm
UDS520NB30	Arc Endcap	68 X 306 mm	52 X 300 mm	46 X 294 mm	1,930 kg	160 X 340 X 100 mm
UDS520NB35	Arc Endcap	68 X 356 mm	52 X 350 mm	46 X 344 mm	2,245 kg	160 X 390 X 100 mm
UDS520NB40	Arc Endcap	68 X 406 mm	52 X 400 mm	46 X 394 mm	2,560 kg	160 X 440 X 100 mm
UDS520NB45	Arc Endcap	68 X 456 mm	52 X 450 mm	46 X 444 mm	2,875 kg	160 X 490 X 100 mm

WALL SIGN SYSTEM 74 mm : Silver anodised aluminium					WEIGHT	PACKING SIZE (10 Pcs)
ARTICLE	MODEL	EXTERNAL (x-y)	POSTER	COPY	WITH PACKING	*W X H X D
UDS740NA15	Flat Endcap	90 X 156 mm	74 X 150 mm	68 X 150 mm	1,080 kg	210 X 190 X 100 mm
UDS740NA20	Flat Endcap	90 X 206 mm	74 X 200 mm	68 X 200 mm	1,430 kg	210 X 240 X 100 mm
UDS740NA25	Flat Endcap	90 X 256 mm	74 X 250 mm	68 X 250 mm	1,780 kg	210 X 290 X 100 mm
UDS740NA30	Flat Endcap	90 X 306 mm	74 X 300 mm	68 X 300 mm	2,100 kg	210 X 340 X 100 mm
UDS740NA35	Flat Endcap	90 X 356 mm	74 X 350 mm	68 X 350 mm	2,460 kg	210 X 390 X 100 mm
UDS740NA40	Flat Endcap	90 X 406 mm	74 X 350 mm	68 X 400 mm	2,510 kg	210 X 440 X 100 mm
UDS740NA45	Flat Endcap	90 X 456 mm	74 X 450 mm	68 X 450 mm	2,860 kg	210 X 490 X 100 mm
UDS740NA50	Flat Endcap	90 X 506 mm	74 X 500 mm	68 X 500 mm	3,22 kg	210 X 540 X 100 mm
UDS740NB15	Arc Endcap	90 X 156 mm	74 X 150 mm	68 X 144 mm	1,080 kg	210 X 190 X 100 mm
UDS740NB20	Arc Endcap	90 X 206 mm	74 X 200 mm	68 X 194 mm	1,430 kg	210 X 240 X 100 mm
UDS740NB25	Arc Endcap	90 X 256 mm	74 X 250 mm	68 X 244 mm	1,780 kg	210 X 290 X 100 mm
UDS740NB30	Arc Endcap	90 X 306 mm	74 X 300 mm	68 X 294 mm	2,100 kg	210 X 340 X 100 mm
UDS740NB35	Arc Endcap	90 X 356 mm	74 X 350 mm	68 X 344 mm	2,460 kg	210 X 390 X 100 mm
UDS740NB40	Arc Endcap	90 X 406 mm	74 X 350 mm	68 X 394 mm	2,510 kg	210 X 440 X 100 mm
UDS740NB45	Arc Endcap	90 X 456 mm	74 X 450 mm	68 X 444 mm	2,860 kg	210 X 490 X 100 mm
UDS740NB50	Arc Endcap	90 X 506 mm	74 X 500 mm	68 X 494 mm	3,220 kg	210 X 540 X 100 mm

WALL SIGN SYSTEM 105 mm : Silver anodised aluminium					WEIGHT	PACKING SIZE (10 Pcs)
ARTICLE	MODEL	EXTERNAL (x-y)	POSTER	COPY	WITH PACKING	*W X H X D
UDS105NA25	Flat Endcap	120 X 256 mm	105 X 250 mm	99 X 250 mm	2,350 kg	270 X 290 X 100 mm
UDS105NA30	Flat Endcap	120 X 306 mm	105 X 300 mm	99 X 300 mm	2,830 kg	270 X 340 X 100 mm
UDS105NA35	Flat Endcap	120 X 356 mm	105 X 350 mm	99 X 350 mm	3,260 kg	270 X 390 X 100 mm
UDS105NA40	Flat Endcap	120 X 406 mm	105 X 400 mm	99 X 400 mm	3,740 kg	270 X 440 X 100 mm
UDS105NA50	Flat Endcap	120 X 506 mm	105 X 500 mm	99 X 500 mm	4,700 kg	270 X 540 X 100 mm
UDS105NA60	Flat Endcap	120 X 606 mm	105 X 600 mm	99 X 600 mm	5,860 kg	270 X 640 X 100 mm
UDS105NB25	Arc Endcap	120 X 256 mm	105 X 250 mm	99 X 244 mm	2,350 kg	270 X 290 X 100 mm
UDS105NB30	Arc Endcap	120 X 306 mm	105 X 300 mm	99 X 294 mm	2,830 kg	270 X 340 X 100 mm
UDS105NB35	Arc Endcap	120 X 356 mm	105 X 350 mm	99 X 344 mm	3,260 kg	270 X 390 X 100 mm
UDS105NB40	Arc Endcap	120 X 406 mm	105 X 400 mm	99 X 394 mm	3,740 kg	270 X 440 X 100 mm
UDS105NB50	Arc Endcap	120 X 506 mm	105 X 500 mm	99 X 494 mm	4,700 kg	270 X 540 X 100 mm
UDS105NB60	Arc Endcap	120 X 606 mm	105 X 600 mm	99 X 594 mm	5,860 kg	270 X 640 X 100 mm

WALL SIGN SYSTEM 148 mm : Silver anodised aluminium					WEIGHT	PACKING SIZE (10 Pcs)
ARTICLE	MODEL	EXTERNAL (x-y)	POSTER	COPY	WITH PACKING	*W X H X D
UDS148NA30	Flat Endcap	162 X 306 mm	148 X 300 mm	142 X 300 mm	3,360 kg	360 X 340 X 100 mm
UDS148NA35	Flat Endcap	162 X 356 mm	148 X 350 mm	142 X 350 mm	3,960 kg	360 X 390 X 100 mm
UDS148NA40	Flat Endcap	162 X 406 mm	148 X 400 mm	142 X 400 mm	4,540 kg	360 X 440 X 100 mm
UDS148NA50	Flat Endcap	162 X 506 mm	148 X 500 mm	142 X 500 mm	5,660 kg	360 X 540 X 100 mm
UDS148NA60	Flat Endcap	162 X 606 mm	148 X 600 mm	142 X 600 mm	6,860 kg	360 X 640 X 100 mm
UDS148NA65	Flat Endcap	162 X 656 mm	148 X 650 mm	142 X 650 mm	7,410 kg	360 X 690 X 100 mm
UDS148NB30	Arc Endcap	162 X 306 mm	148 X 300 mm	142 X 294 mm	3,360 kg	360 X 340 X 100 mm
UDS148NB35	Arc Endcap	162 X 356 mm	148 X 350 mm	142 X 344 mm	3,960 kg	360 X 390 X 100 mm
UDS148NB40	Arc Endcap	162 X 406 mm	148 X 400 mm	142 X 394 mm	4,540 kg	360 X 440 X 100 mm
UDS148NB50	Arc Endcap	162 X 506 mm	148 X 500 mm	142 X 494 mm	5,660 kg	360 X 540 X 100 mm
UDS148NB60	Arc Endcap	162 X 606 mm	148 X 600 mm	142 X 594 mm	6,860 kg	360 X 640 X 100 mm
UDS148NB65	Arc Endcap	162 X 656 mm	148 X 650 mm	142 X 644 mm	7,410 kg	360 X 690 X 100 mm



*W:Width H: Height D: Depth

Wall Sign Double Sided



Fast and Simple! Aluminium wall sign profiles are designed to create horizontally curved double sided suspended signs. Using your stock of single sided profiles, product offerings can be increased to double sided suspension style. Double Sided Wall Sign is suitable as directional signs, way finding. Suspension cables enclosed enables flexible positioning of the sign. Black endcaps complete the look.

Schnell und einfach. Die Aluminium Profile sind konzipiert um horizontale gewölbte doppelseitige Wegweiser bestens zu positionieren. Durch aneinanderstecken der einseitigen Profile kann man hier die doppelseitigen Wallsign erhalten. Die doppelseitigen Wallsign sind geeignet für direkte Wegweiser. Die beigelegten Montageeile ermöglichen eine flexible Montage der Wegweiser. Schwarze Endkappen vervollständigen die Optik.

 Use the suction cup enclosed to easily remove the insert. Peel the tape on the backing and stick for easy application. Der beigelegte Saugnapf ermöglicht das Auswechseln des Inhaltes. Ziehen Sie die Folie auf der Rückseite ab und kleben Sie das Produkt einfach an.

 Compatible signage methods; printed papers from common printers, cut vinyl, digitally printed vinyl, screen-printed materials. Kompatible Druckmethoden geeignet, bedrucktes Papier, vinyl, digital bedrucktes vinyl.

 Ceiling suspension is included in the pack (8m wire cable & 2 x ceiling hanger). Individually packed. Das Aufhänageset ist erhältlich als Paket (8m Seil & und 2 Aufhänger). Einzelverpackung.

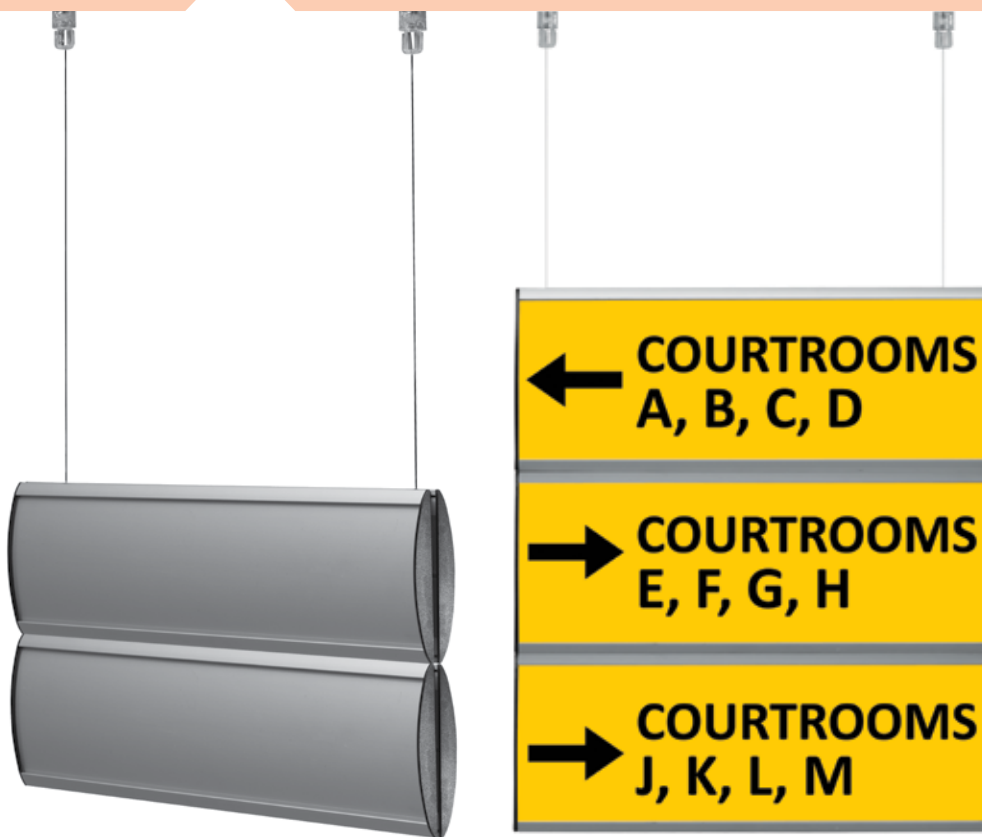

- ✓ Anti-reflex PET covers ensure clarity of message.
- ✓ Easy to access poster with suction cup provided in the pack.
- ✓ Easy to update messages. Suitable for paper, plastic or any flexible material up to 1mm thick.
- ✓ Available in standard sizes as well as bespoke sizes (subjected to moq).
- ✓ For more than 5 layers please contact to your sales executive.
- ✓ Antireflex Folie bietet Schutz und eine klare Sicht auf die Nachricht
- ✓ Der beigelegte Saugnapf ermöglicht das Einfache auswechseln des Inhaltes
- ✓ Sehr bequemer Austausch der Nachricht. Geeignet für Papier, PVC oder einem anderen flexible Material bis zu einer Stärke von 1mm.
- ✓ Erhältlich in Standardmaßen so wie auch in Sondermaßen (vorausgesetzt einer gewissen Mindestabnahmemenge)
- ✓ Für mehr als 5 Reihen, kontaktieren Sie bitte Ihren Kundenbetreuer



Suction Cup / UYAA006010



Fixing components (UYPDS00002)
Suspension set (UYPDS00001)

WALL SIGN DOUBLE SIDED		
ARTICLE	DESCRIPTION	WEIGHT
UYPDS00001	Double Sided Suspension Set / 2x4 m fishnet & 2xCeiling Hanger	0,450 kg
UYPDS00002	Double Sided Fixing Set (4 Pcs)	0,050 kg



Maximum recommended length: 500 mm

WALL SIGN DOUBLE SIDED: Silver anodised aluminium					
	SINGLE LAYER	2-LAYER	3-LAYER	4-LAYER	5-LAYER
74 mm	✓	✓	✓	✓	✓
105 mm	✓	✓	✓	✓	
148 mm	✓	✓	✓		

Toilet Logo Systems Chrome



Chrome coated 3D toilet signs are available for men and women in 92 mm and clean neat finish add value to the signs. Easy to apply on the door or wall with self-adhesive tape provided on the back of each sign.

Die Verchromten Toilettenszeichen sind verfügbar für Frauen und Männer und in einer Höhe von 92mm erhältlich. Die saubere Verarbeitung verleiht den Zeichen einen edlen Look. Sehr einfache Montage auf der Tür oder an der Wand mit doppelseitigem Klebeband welches auf der Rückseite schon angeklebt ist.

 Peel the tape and stick backing for easy application. Please clean the surface before applying the double-sided tape for better application. Ziehen Sie die Schutzschicht ab und kleben Sie die Rückseite an die Oberfläche. Flächen vor dem anbringen des doppelseitigen Klebebands gründlich reinigen, um besseren Halt zu gewährleisten.



TDFJ92W002
Chromed Toilet
Signs, Women



TDFJ92X002
Chromed Toilet
Signs, Men

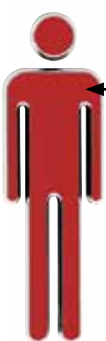

Back Side



Double sided tape



TDFJ100C01
Chromed Toilet Signs,
Handicap, Grey Panel



TDFJ100W01
Chromed Toilet
Signs, Women,
Grey Panel



TDFJ100X01
Chromed Toilet
Signs, Men,
Grey Panel



Back Side

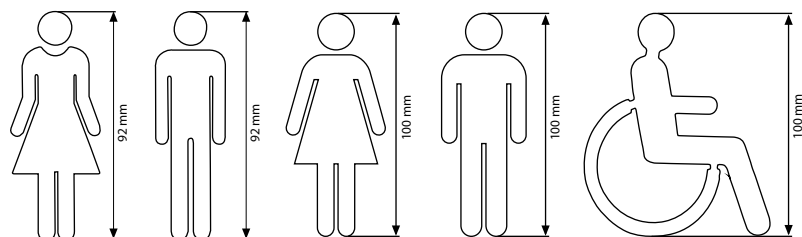

MATERIAL: Chrome			WEIGHT	PACKING SIZE (50 Pcs)
ARTICLE	HEIGHT	DESCRIPTION	WITH PACKING	*W X H X D
TDFJ92X002	92 mm	Silver- Men	0,008 kg	145 X 195 X 110 mm
TDFJ92W002	92 mm	Silver- Women	0,008 kg	145 X 195 X 110 mm
TDFJ100X01	100 mm	Grey Panel - Men	0,014 kg	175 X 200 X 110 mm
TDFJ100W01	100 mm	Grey Panel - Women	0,014 kg	175 X 200 X 110 mm
TDFJ100C01	100 mm	Grey Panel - Handicap	0,013 kg	175 X 200 X 110 mm

*W:Width H: Height D: Depth



Decorative Toilet Signs



Oval shape plastic injected toilet signs has both colour and size options: Gold, Silver and Bronze & 120mm and 150mm heights. Braided frame and leather-textured backing completes elegant look.

Diese ovalen im Plastik Spritzverfahren hergestellten Zeichen, sind in verschiedenen Versionen erhältlich: Gold, Silber und Bronze & 120mm und 150mm Höhen. Geflochten und mit Leder überzogen sind diese Zeichen in einem eleganten Look verfügbar.

 Peel the tape and stick backing for easy application. Please clean the surface before applying the double-sided tape for better application.
Ziehen Sie die Schutzschicht ab und kleben Sie die Rückseite an die Oberfläche. Flächen vor dem anbringen des doppelseitigen Klebebands gründlich reinigen, um besseren Halt zu gewährleisten.



Silver Frame,
Dark Grey Panel, Men



Silver Frame,
Dark Grey Panel, Women



Gold Frame,
Dark Grey Panel, Men



Gold Frame,
Dark Grey Panel, Women



Bronze Frame,
Dark Grey Panel, Men



Bronze Frame,
Dark Grey Panel, Women



Double sided tape

Back

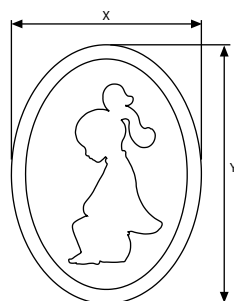
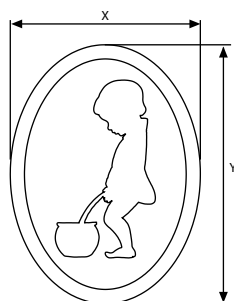

MATERIAL: Plastic injected			WEIGHT	PACKING SIZE (50 Pcs)
ARTICLE	EXTERNAL (x-y)	DESCRIPTION	WITH PACKING	*W X H X D
TDFY28LF03	88 X 120 mm	Gold - Men	0,040 kg	205 X 240 X 170 mm
TDFY28WF03	88 X 120 mm	Gold - Women	0,040 kg	205 X 240 X 170 mm
TDFY29LF02	110 X 150 mm	Silver - Men	0,066 kg	235 X 330 X 175 mm
TDFY29WF02	110 X 150 mm	Silver - Women	0,066 kg	235 X 330 X 175 mm
TDFY31LF04	110 X 150 mm	Bronze - Men	0,066 kg	235 X 330 X 175 mm
TDFY31WF04	110 X 150 mm	Bronze - Women	0,066 kg	235 X 330 X 175 mm

*W:Width H: Height D: Depth



Aluminum Panel Braille Signs



Aluminium Braille Toilet Signs are plastic framed. The signs are incorporated a combination of tactile text and printed text. It is available in Men and Women options. Easy to apply with double sided tape provided on the back of each sign.

Diese Plastik Rahmen haben ein Maß von 150x150mm. Diese Zeichen verfügen über einen bedruckten Text und einer blinden Schrift in einem. Der Text ist als „Frauen“ und „Männer“ verfügbar. Einfache Montage durch doppelseitiges Klebeband angebracht auf der Rückseite der Zeichen.

 Peel the tape and stick backing for easy application. Please clean the surface before applying the double-sided tape for better application. Ziehen Sie die Schutzschicht ab und kleben Sie die Rückseite an die Oberfläche. Flächen vor dem anbringen des doppelseitigen Klebebands gründlich reinigen, um besseren Halt zu gewährleisten.

5x5 Aluminium Panel Braille Signs



127x127 mm -No Smoking, Silver Plastic Frame Aluminum Panel With Braille

6x6 Aluminium Panel Braille Signs



150 x150 mm-Men, Silver Plastic Frame Aluminum Panel With Braille



150 x150 mm-Female, Silver Plastic Frame Aluminum Panel With Braille

6x8 Aluminium Panel Braille Signs



150x200 mm-Men, Silver Plastic Frame Aluminum Panel With Braille



150x200 mm-Female, Silver Plastic Frame Aluminum Panel With Braille



5x5 Aluminium Panel Braille Signs

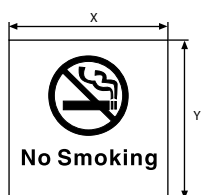

6x6 Aluminium Panel Braille Signs

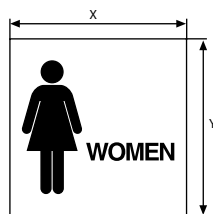

6x8 Aluminium Panel Braille Signs

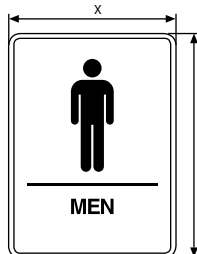

6X8 BARILLE SIGN: Aluminium			WEIGHT	PACKING SIZE (50 Pcs)
ARTICLE	EXTERNAL (x-y)	DESCRIPTION	WITH PACKING	*W X H X D
TDFL070002	150 X 200 mm	Silver- Men	0,142 kg	235 X 420 X 205 mm
TDFL080002	150 X 200 mm	Silver - Women	0,142 kg	235 X 420 X 205 mm

6X6 BARILLE SIGN: Aluminium			WEIGHT	PACKING SIZE (50 Pcs)
ARTICLE	EXTERNAL (x-y)	DESCRIPTION	WITH PACKING	*W X H X D
TDFL050002	150 X 150 mm	Silver- Men	0,112 kg	235 X 420 X 205 mm
TDFL060002	150 X 150 mm	Silver - Women	0,112 kg	235 X 420 X 205 mm

5X5 BARILLE SIGN: Aluminium			WEIGHT	PACKING SIZE
ARTICLE	EXTERNAL (x-y)	DESCRIPTION	WITH PACKING	*W X H X D
TDFL110002	127 X 127 mm	Silver	0,066 kg	235 X 420 X 205 mm (50 pcs)

*W:Width H: Height D: Depth



ABS Plastic Braille Signs



Chrome framed Braille Signs are made of plastics. The signs incorporated a combination of tactile text and printed text. It has Men, Women, No Smoking and Exit options. Easy to apply with self-adhesive tape provided on the back of each sign.

Die Braille Signs mit einem verchromten Rahmen sind hergestellt aus Plastik. Diese Zeichen verfügen über einen bedruckten Text und einer blinden Schrift in einem. Es sind Frauen und Männer wie auch No Smoking und Exit im Programm enthalten. Einfache Montage durch doppelseitiges Klebeband angebracht auf der Rückseite der Zeichen.

 Peel the tape and stick backing for easy application. Please clean the surface before applying the double-sided tape for better application. Ziehen Sie die Schutzschicht ab und kleben Sie die Rückseite an die Oberfläche. Flächen vor dem anbringen des doppelseitigen Klebebands gründlich reinigen, um besseren Halt zu gewährleisten.



WOMEN, Braille signs. With double-side tape on the back.



MEN, Braille signs. With double-side tape on the back.



EXIT, braille signs. With double-side tape on the back.



NO SMOKING, braille signs. With double-side tape on the back.



Back side

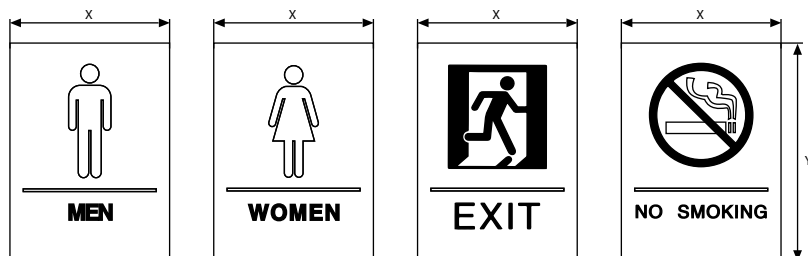

MATERIAL: Plastic			WEIGHT	PACKING SIZE
ARTICLE	EXTERNAL (x-y)	DESCRIPTION	WITH PACKING	*W X H X D
TDFY010002	150 X 200 mm	Silver - Men	0,180 kg	235 X 330 X 235 mm (50 pcs)
TDFY020002	150 X 200 mm	Silver - Women	0,180 kg	235 X 330 X 235 mm (50 pcs)
TDFY090002	150 X 200 mm	Silver - No Smoking	0,180 kg	235 X 330 X 235 mm (50 pcs)
TDFY100002	150 X 200 mm	Silver - Exit	0,180 kg	235 X 330 X 235 mm (50 pcs)

*W:Width H: Height D: Depth





Plastic Chromed House Numbers



Chrome coated plastic House Numbers offered in a pack 0-9. Easy to apply on various surfaces with self-adhesive tape on the back of each sign.

Verchromte Plastik Hausnummern sind in einem Paket das 0-9 beinhaltet erhältlich. Einfache Montage durch doppelseitiges Klebeband angebracht auf der Rückseite der Zeichen.

 Peel the tape and stick backing for easy application. Ziehen Sie die Schutzschicht ab und kleben Sie die Rückseite an die Oberfläche.

 One pack includes 0-9. Eine Packungseinheit enthält 0-9.

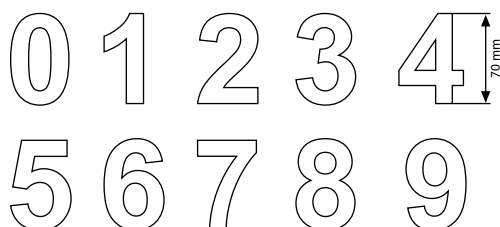

MATERIAL: Chrome coated plastic			WEIGHT	PACKING SIZE
ARTICLE	HEIGHT	DESCRIPTION	WITH PACKING	*W X H X D
TDFH700002	70 mm	Silver - 0-9	0,014 kg	255 X 310 X 335 mm (50 pcs)



* W:Width H:Height D:Depth

Standoff Mount Acrylic Sign



See movie at our website www.mtdisplays.com.tr



Designed as frameless, Standoff Mount Acrylic Sign is a practical display system allowing to change poster when it is still on the wall by sliding. It is suitable for environments where the advertisement or promotions are changed very often such as offices, meeting rooms, travel agents, hotels, restaurants and many more. Standoff Mount Acrylic Sign is also suitable for branding.

Der rahmenlose Standoff Mount Acrylic Sign ist ein praktisches Display System welches den Posterwechsel auch direkt an der Wand ermöglicht durch seitliches einschieben. Es ist geeignet für Umgebungen wo sehr häufig ein Posterwechsel durchgeführt wird; wie zum Beispiel Büro, Konferenzräume, Reiseagenturen, Hotels, Restaurants und viele mehr. Standoff Mount Acrylic Sign ist auch für Logodrucke geeignet.

Peel off the film.
Vor Gebrauch den Schutzfilm abziehen.

Handle with care during transportation. Peel of the film over the product before use.
Seien Sie beim Transport vorsichtig. Ziehen Sie die Schutzfolie ab bevor Sie das Produkt verwenden.

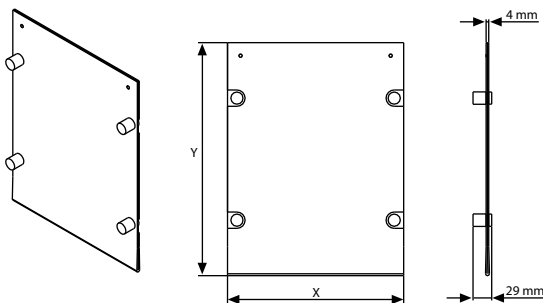

Fixing kit included.

MATERIAL : Clear acrylic 2 mm		WEIGHT	PACKING SIZE
ARTICLE	EXTERNAL (x-y)	WITH PACKING	*W X H X D
USMS0000A4	270 X 357 mm	2,900 kg	300 X 460 X 45 mm (5 Pcs)
USMS0000A3	357 X 480 mm	4,700 kg	380 X 590 X 45 mm (5 Pcs)
USMS0000A2	480 X 654 mm	2,300 kg	500 X 690 X 40 mm

*W:Width H: Height D: Depth

